

Service client
04 42 52 33 05

5 ans
Garantie

5 semaines
Délais

Livraison & Installation

Eco taxe

%
Remise

Bon de commande

SPIDER



La classe à l'italienne



SPIDER



Service client
04 42 52 33 05

5 ans
Garantie

5 semaines
Délais

Livraison & Installation

Eco taxe

Remise

Bon de commande





SPIDER



Service client
04 42 52 33 05

5 ans
Garantie

5 semaines
Délais



Livraison & Installation

Eco taxe

Remise



Bon de commande



Caractéristiques

Composition bureau

1. plateau bureau
2. support plateau
3. pieds bureau
4. poutre structurale
5. voile de fond
6. top unité central
7. bottom unité central
8. tiroir
9. porte coulissante
10. passe câbles

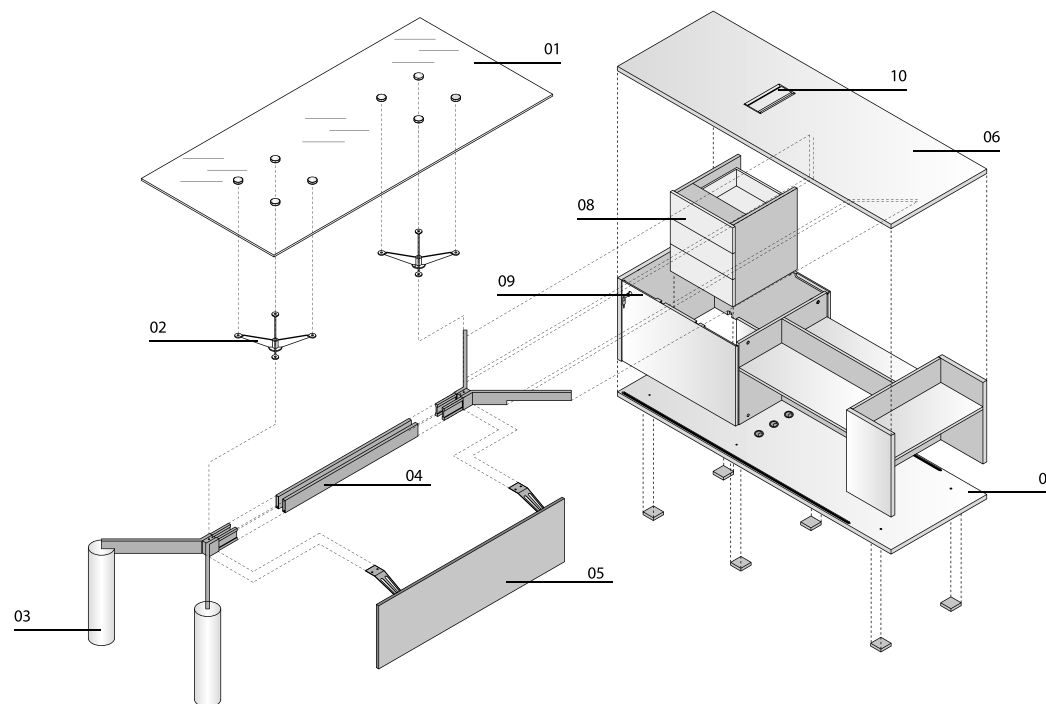

Finitions

VB - Verre brillant (plateau et table)

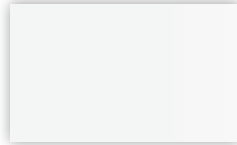

80 Blanc



82 Noir

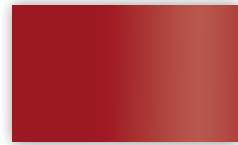

84 Rouge

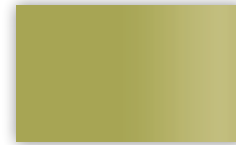

54 Vert acide

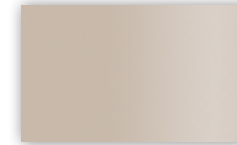

52 Champagne

VA - Verre anti touch (plateau et table)



53 Cappucino

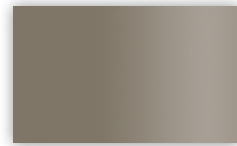

51 Mink

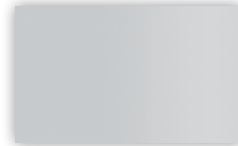

55 Pearl

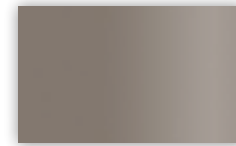

57 Fumée

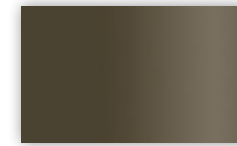

56 Bronze

VT - Verre (plateau et table)

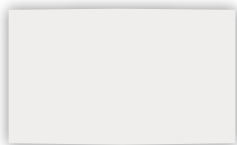

00 Transparent

ME - Mélaminé (voile de fond, caisson et table)

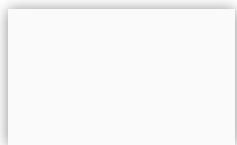

20 Blanc

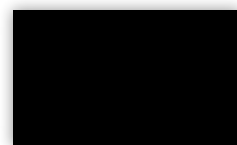

04 Noir

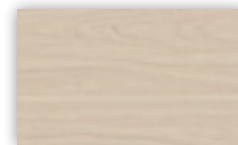

70 Elm

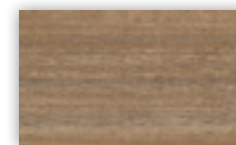

74 Walnut

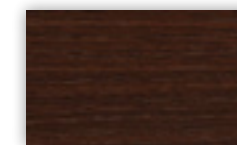

76 Marron foncé

Finitions

LC - Polish (caisson) 🐢

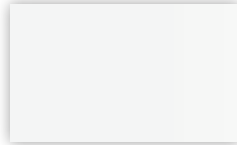

80 Blanc



82 Noir

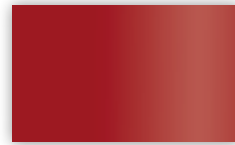

84 Rouge

MO - Metal mat (structure, pieds et accessoires)

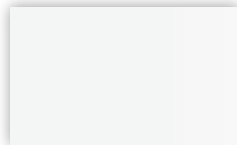

20 Blanc

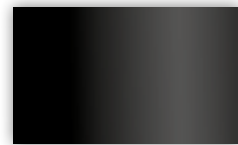

04 Noir

ML - Metal poli (structure, pieds et accessoires)

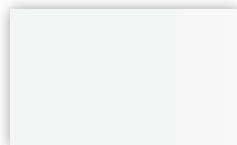

80 Blanc



82 Noir

PL - Cuir (portes) 🐢

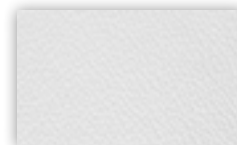

90 Blanc

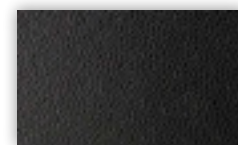

92 Noir

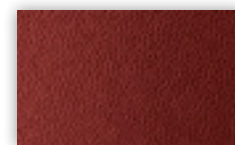

94 Rouge

Finitions

SP - Spécial (portes)

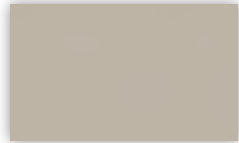

26 Beige



23 Capuccino

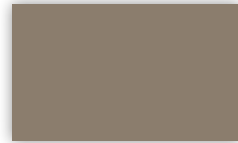

25 Tabacco



31 Powder pink

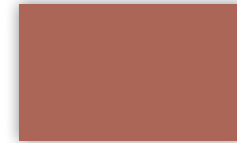

21 Copper

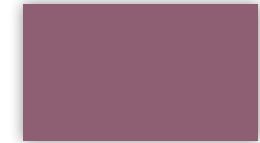

27 Violet



32 Curry

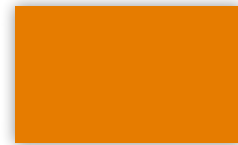

22 Orange

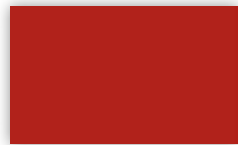

29 Rouge

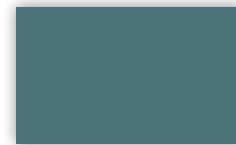

33 Huile

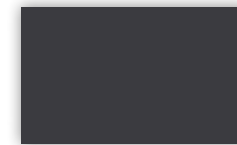

30 Basalte



Service client
04 42 52 33 05

5 ans
Garantie

5 semaines
Délais

Livraison & Installation

Eco taxe

Remise

Bon de commande

Tarifs - Bureaux

Service client
04 42 52 33 05

Bureau

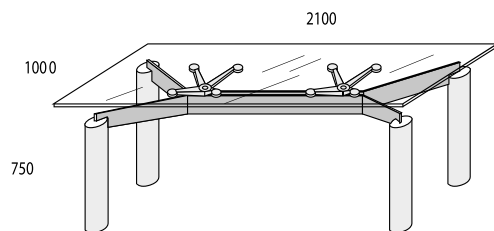

Élément de support métallique de la même couleur que la structure

L.2500 P.1000 H.750 mm

RSC02110-MO(*)

VT*
Verre transparent

3.512,00 €

VB*
Verre brillant

3.284,00 €

VA*
Verre anti touch

3.412,00 €

L.2500 P.1000 H.750 mm

RSC02110-ML(*)

4.289,00 €

4.062,00 €

4.189,00 €

Éléments de support moulés sous pression en aluminium chromé

L.2500 P.1000 H.750 mm

RSC02110-MO(*)

4.018,00 €

3.790,00 €

3.918,00 €

L.2500 P.1000 H.750 mm

RSC02110-ML(*)

4.745,00 €

4.517,00 €

4.645,00 €

(*) code finition page 4 à 6

Bureau

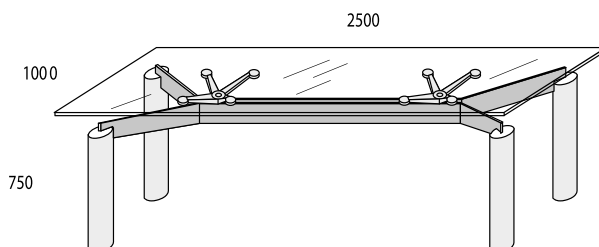

Élément de support métallique de la même couleur que la structure

L.2500 P.1000 H.750 mm

RSC02510-MO(*)

VT*
Verre transparent

3.696,00 €

VB*
Verre brillant

3.485,00 €

VA*
Verre anti touch

3.638,00 €

L.2500 P.1000 H.750 mm

RSC02510-ML(*)

4.493,00 €

4.282,00 €

4.435,00 €

Éléments de support moulés sous pression en aluminium chromé

L.2500 P.1000 H.750 mm

RSC02510-MO(*)

4.202,00 €

3.991,00 €

4.144,00 €

L.2500 P.1000 H.750 mm

RSC02510-ML(*)

4.948,00 €

4.737,00 €

4.890,00 €

(*) code finition page 4 à 6

Voile de fond

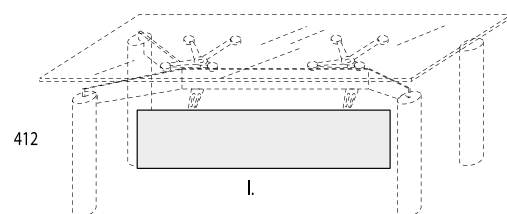

Pour bureaux L.2100 mm

L. 1500 x h. 412 mm

SIS150-MO(*)

218,00 €

292,00 €

L. 1500 x h. 412 mm

SIS150-ML(*)

275,00 €

349,00 €

Pour bureaux L.2500 mm

L. 1900 x h. 412 mm

SIS190-MO(*)

242,00 €

329,00 €

L. 1900 x h. 412 mm

SIS190-ML(*)

300,00 €

387,00 €

(*) code finition page 4 à 6

5 ans
Garantie

5 semaines
Délais



Livraison & Installation

Eco taxe

Remise



Bon de commande



Tarifs - Bureaux

Service client
04 42 52 33 05

5 ans
Garantie

5 semaines
Délais



Livraison & Installation

Eco taxe

Remise



Bon de commande

Plateau bureau sur unité central

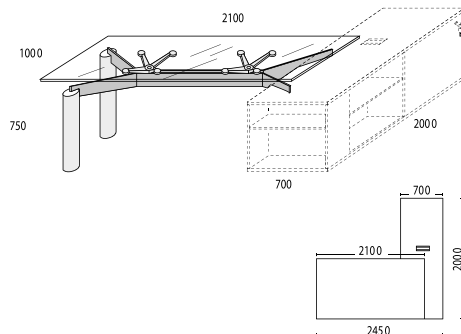

Élément de support métallique de la même couleur que la structure

L.2100 P.1000 H.750 mm

RSC12110-MO(*)

VT*
Verre transparent

3.112,00 €

VB*
Verre brillant

2.885,00 €

VA*
Verre anti touch

3.012,00 €

L.2100 P.1000 H.750 mm

RSC12110-ML(*)

3.672,00 €

3.445,00 €

3.770,00 €

Éléments de support moulés sous pression en aluminium chromé

L.2100 P.1000 H.750 mm

RSC02110-MO(*)

3.618,00 €

3.391,00 €

3.518,00 €

L.2100 P.1000 H.750 mm

RSC02110-ML(*)

3.803,00 €

3.592,00 €

3.745,00 €

(*) code finition page 4 à 6

Plateau bureau sur unité central

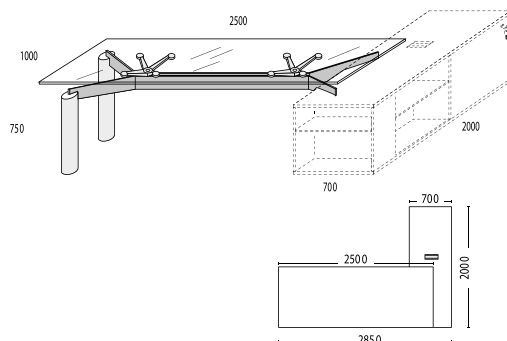

Élément de support métallique de la même couleur que la structure

L.2500 P.1000 H.750 mm

RSC12510-MO(*)

VT*
Verre transparent

3.297,00 €

VB*
Verre brillant

3.086,00 €

VA*
Verre anti touch

3.239,00 €

L.2500 P.1000 H.750 mm

RSC12510-ML(*)

3.876,00 €

3.665,00 €

3.572,00 €

Éléments de support moulés sous pression en aluminium chromé

L.2500 P.1000 H.750 mm

RSC12510-MO(*)

4.128,00 €

3.900,00 €

4.028,00 €

L.2500 P.1000 H.750 mm

RSC12510-ML(*)

4.128,00 €

3.900,00 €

4.028,00 €

(*) code finition page 4 à 6

Voile de fond

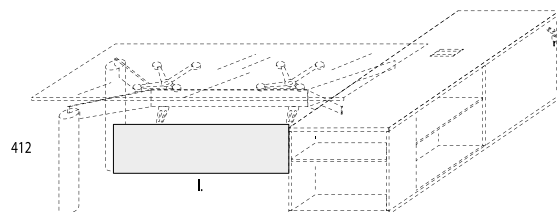

Pour bureaux L.2100 mm

L. 1400 x h. 412 mm

SIS140-MO(*)

ME*
Mélaminé

215,00 €

LC*
poli

283,00 €

L. 1400 x h. 412 mm

SIS140-ML(*)

272,00 €

340,00 €

Pour bureaux L.2500 mm

L. 1800 x h. 412 mm

SIS180-MO(*)

238,00 €

311,00 €

L. 1800 x h. 412 mm

SIS180-ML(*)

295,00 €

368,00 €

(*) code finition page 4 à 6



Tarifs - Bureaux

Service client
04 42 52 33 05

5 ans
Garantie

5 semaines
Délais



Livraison & Installation

Eco taxe

Remise



Bon de commande

Extension

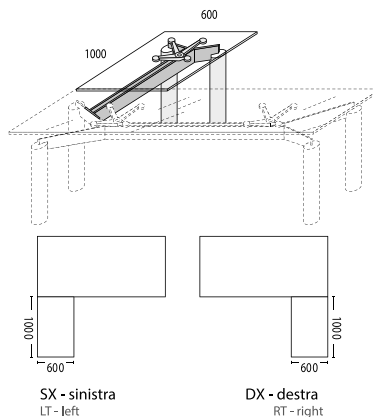

VT*	VB*	VA*
Verre transparent	Verre brillant	Verre anti touch

Élément de support métallique de la même couleur que la structure

L.1000 P.600 H.750 mm	RDT01006-MO(*)	1.791,00 €	1.704,00 €	1.742,00 €
L.2100 P.1000 H.750 mm	RDT01006-ML(*)	2.309,00 €	2.020,00 €	2.054,00 €

Éléments de support moulés sous pression en aluminium chromé

L.1000 P.600 H.750 mm	RDT01006-MO(*)	2.039,00 €	1.952,00 €	1.989,00 €
L.1000 P.600 H.750 mm	RDT01006-ML(*)	2.532,00 €	2.445,00 €	2.532,00 €

(*) code finition page 4 à 6

Plateau bureau sur unité central

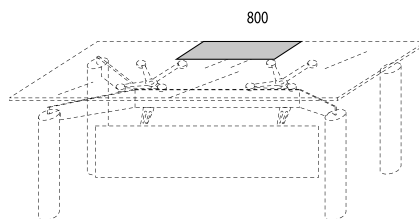

PL*
Cuir

Élément de support métallique de la même couleur que la structure

L.800 P.500	ST015	253,00 €
-------------	-------	----------

(*) code finition page 4 à 6

Extension table conférence

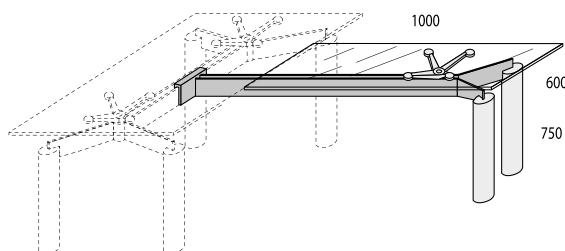

VT*	VB*	VA*
Verre transparent	Verre brillant	Verre anti touch

Élément de support métallique de la même couleur que la structure

L.1000 P.600 H.750 mm	RTC01006-MO(*)	1.825,00 €	1.738,00 €	1.776,00 €
L.2100 P.1000 H.750 mm	RTC01006-ML(*)	2.374,00 €	2.287,00 €	2.325,00 €

Éléments de support moulés sous pression en aluminium chromé

L.1000 P.600 H.750 mm	RTC01006-MO(*)	2.073,00 €	1.986,00 €	1.990,00 €
L.1000 P.600 H.750 mm	RTC01006-ML(*)	2.596,00 €	2.510,00 €	2.437,00 €

(*) code finition page 4 à 6

Tarifs - Caissons

Service client
04 42 52 33 05

Caisson



Caisson 3 tiroirs sur roulettes avec serrure
L.432 P.496 H.572 mm

CAL334N

ME*
Mélaminé

LC*
Poli

324,00 €

453,00 €

(* code finition page 4 à 6

Extension

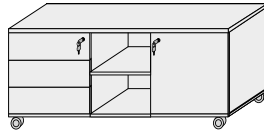

Unité d'extension sur roulettes
L.1228 P.496 H.572 mm

SVP125

ME*
Mélaminé

LC*
Poli

619,00 €

948,00 €

(* code finition page 4 à 6

Amorti tiroir

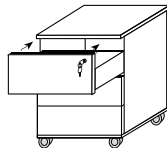

Guide amortissement tiroir

MG103

66,00 €

(* code finition page 4 à 6

Tiroir

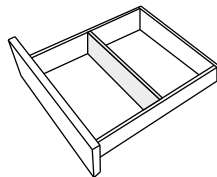

Tiroir avec séparation accessoires

AC00001

9,00 €

(* code finition page 4 à 6

Plateau

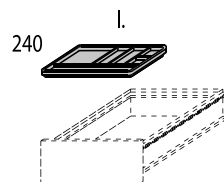

Plateau en plastique

AC00002

11,00 €

(* code finition page 4 à 6

5
ans
Garantie

5
semaines
Délais



Livraison & Installation

Eco taxe

Remise



Bon de commande

Tarifs - Unité central

Unité central

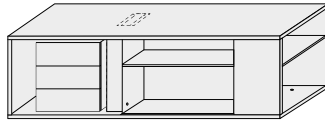

Unité de service avec tiroir de piédestal intérieur et guides d'extraction total amorti
L.2000 P.700 H.590 mm SVP200

Ajout de porte obligatoire.

(*) code finition page 4 à 6

ME*
Mélaminé

1.252,00 €

LC*
Poli

1.643,00 €

Porte unité central

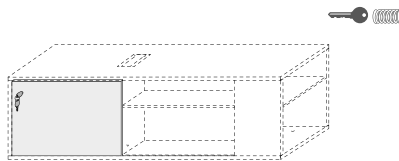

Portes coulissantes pour unité de service
L.830 A1188651

(*) code finition page 4 à 6

ME*
Mélaminé

329,00 €

SP*
Spécial

354,00 €

LC*
Poli

372,00 €

PL*
Cuir

594,00 €

Plateau

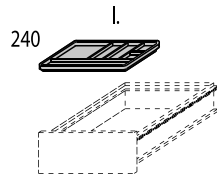

Unité de service avec tiroir de piédestal intérieur et guides d'extraction total amorti
L.2000 P.700 H.590 mm AC00001

11,00 €

Service client
04 42 52 33 05

5
ans
Garantie

5
semaines
Délais

Livraison & Installation

Eco taxe

Remise

Bon de commande

Tarifs - Tables

Service client
04 42 52 33 05

5
ans
Garantie

5
semaines
Délais

 Livraison & Installation

 Eco taxe

 Remise

 Bon de commande

Table basse ronde avec base en métal

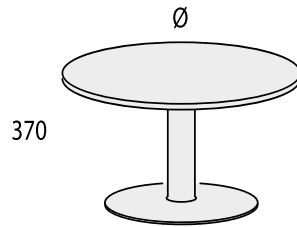

Tables 600 diamètre
Ø. 600 mm
Ø. 600 mm

Tables 800 diamètre
Ø. 800 mm
Ø. 800 mm

(*) code finition page 4 à 6

ME*
Verre transparent

VB*
Verre brillant

VA*
Verre anti touch

CTC10606-MO(*)	395,00 €	665,00 €	689,00 €
CTC10606-ML(*)	569,00 €	839,00 €	863,00 €

CTC10808-MO(*)	432,00 €	807,00 €	846,00 €
CTC10808-ML(*)	550,00 €	891,00 €	927,00 €

h. 378 mm

h. 382 mm

h. 382 mm

Table basse ronde avec plateau en verre transparent et base en métal

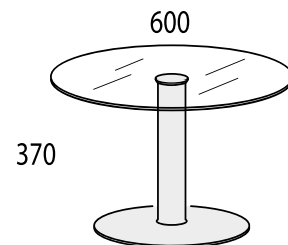

Tables 600 diamètre
Ø. 600 L. 600 x h. 370 mm
Ø. 600 L. 600 x h. 370 mm

(*) code finition page 4 à 6

VT*
Verre

SC121064-MO(*)	645,00 €
SC121064-ML(*)	819,00 €

Table basse ovale avec plateau en verre transparent et base en métal

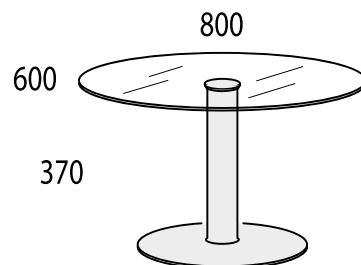

Tables 800 diamètre
Ø. 800 L. 600 x P. 600 x h. 370 mm
Ø. 800 L. 600 x P. 600 x h. 370 mm

(*) code finition page 4 à 6

VT*
Verre

SC121084-MO(*)	685,00 €
SC121084-ML(*)	858,00 €

Tarifs - Accessoires

Service client
04 42 52 33 05

5
ans
Garantie

5
semaines
Délais



Livraison & Installation

Eco taxe

Remise



Bon de commande

Passerelle ronde

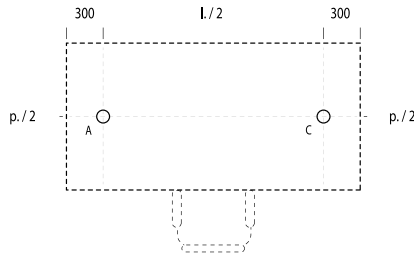
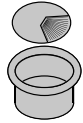

Passerelle câbles 60 diamètre
Ø. 60 mm

CN012

7,00 €

MO*
Métal mat

ML*
Métal poli

Spécifier la position pour faire les trous
Ø. 60 mm

CN101

55,00 €

55,00 €

A Gauche
C Droite

(*) code finition page 4 à 6

Multiprise

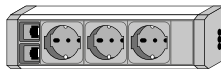

Support de prise shuko et câble d'alimentation

1

CN030

117,00 €

Support de prise shuko et câble d'alimentation + deux RJ45

1

CN031

172,00 €

Passerelle carrée

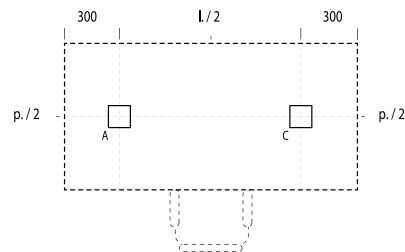
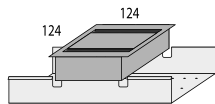

Passerelle câbles 60 diamètre
L. 124 mm

CN109

MO*
Métal mat

ML*
Métal poli

85,00 €

107,00 €

Verre

Crystal

Spécifier la position pour faire les trous
L. 124 mm

CN102

98,00 €

88,00 €

A Gauche
C Droite

(*) code finition page 4 à 6

Tarifs - Accessoires

Passerelle rectangulaire

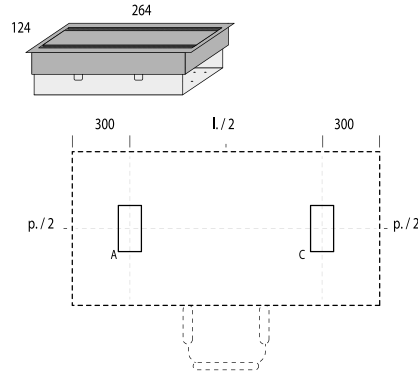

L. 124 mm

CN110

MO*
Métal mat

ML*
Métal poli

96,00 €

119,00€

Verre

Crystal

Spécifier la position pour faire les trous

L. 124 mm

CN102

98,00 €

88,00€

A Gauche
C Droite

(*) code finition page 4 à 6

Service client
04 42 52 33 05

5
ans
Garantie

5
semaines
Délais

Livraison & Installation

Eco taxe

Remise

Bon de commande



Notre sélection

En complément de votre aménagement



Sièges direction PILOTE

A partir de 490€

Selon votre remise

De série :
Assise tapissée
Rotation à 360°
Réglage tension

[Voir la gamme Pilote](#)

Sièges direction KAMELIA

A partir de 508€

Selon votre remise

De série :
Dossier modulable
Réglable en hauteur
Rotation 360°

[Voir la gamme Kamelia](#)

